

MOGICS LIGHT

ML1

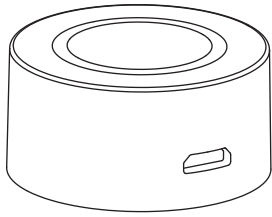

A Revolutionary Multi-Functional Light

Charge

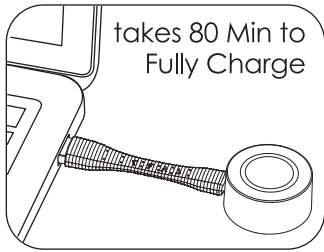

takes 80 Min to Fully Charge

Charge Once For Continual Shine:

- MODE 1: Normal Light **10 Hrs**
- MODE 2: Steady Signal Light **20 Hrs**
- MODE 3: Breathing Light **20 Hrs**
- MODE 4: Flashing Signal Lights **30 Hrs**

Power Indicator:

Red: Charging
A full charge not bright light
Simply Use Tissue Or Cloth To Dry Up The USB Connector Port

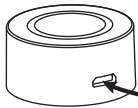

When You First Recieve Your Mogics Light, Be Sure To Charge It Full Before Using To Extend The Maximum Battery Capability.

Switch Mode:

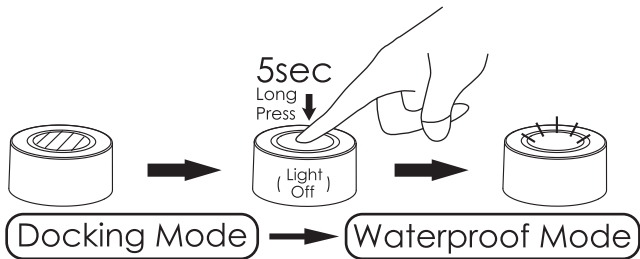
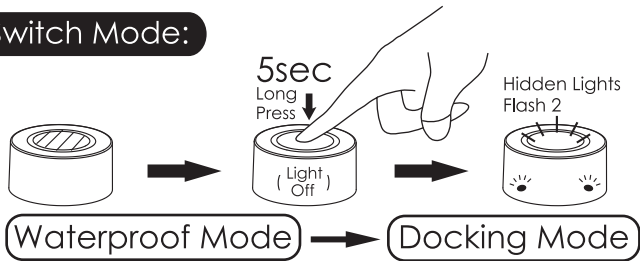

The Swimming Candle

Can Float On Water

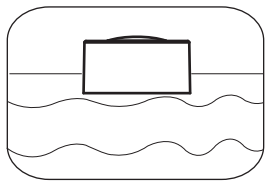

Press Button To Allow Water To Enter

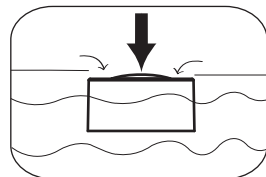

Can Sink To The Bottom

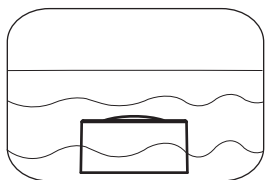

* For Fresh Water Only(8Hours)

4 Lighting Modes

4 種照明模式

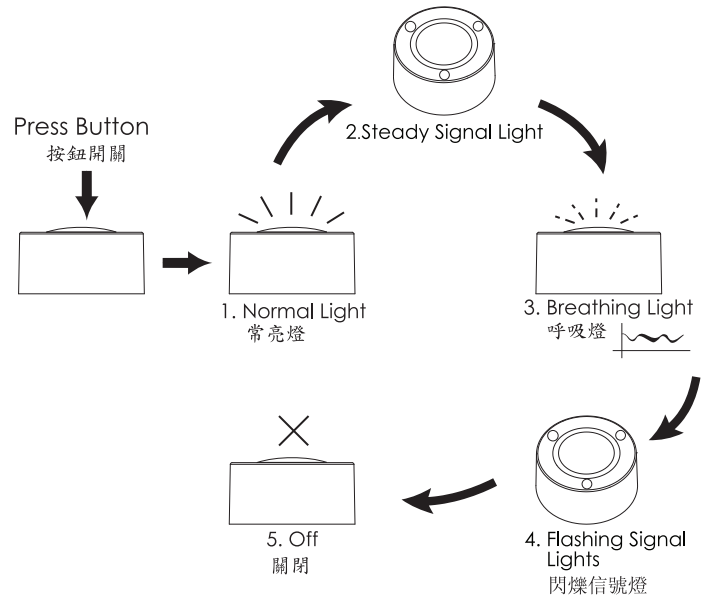

Specifications:

- Designed & Engineered In Singapore
- 300mA Li-ion Polymer Input: DC 5V
- Charging Current :250mA
- Dimensions: 37mm (Diameter) *18mm (High)
- Weight: 18.5g
- Port: Micro USB

High Quality Magnet
強力磁鐵



WARNING!!

警告!!

Strong Magnet
強力磁鐵

Keep Away From Children
遠離兒童

Do Not Swallow
請勿吞食



Maximum Charging

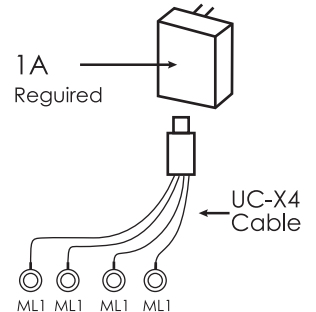

Cautions:

Works with Neodymium Magnets

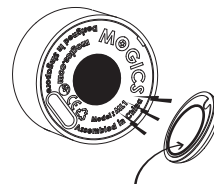

Neodymium Magnet

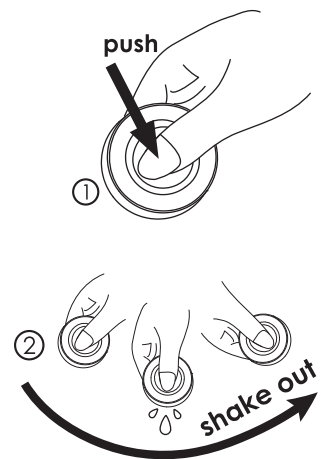

*shake out the water inside mogics light for extend the coating life.

After using in water, shake out the water and place it in a dry area